

REMOTE CONTROL UNIT Model MCU-004

All brand and product names are trademarks, registered trademarks or service marks of their respective holders.

Drill hole for $\varnothing 4 \times 16$ self-tapping screw (four places).

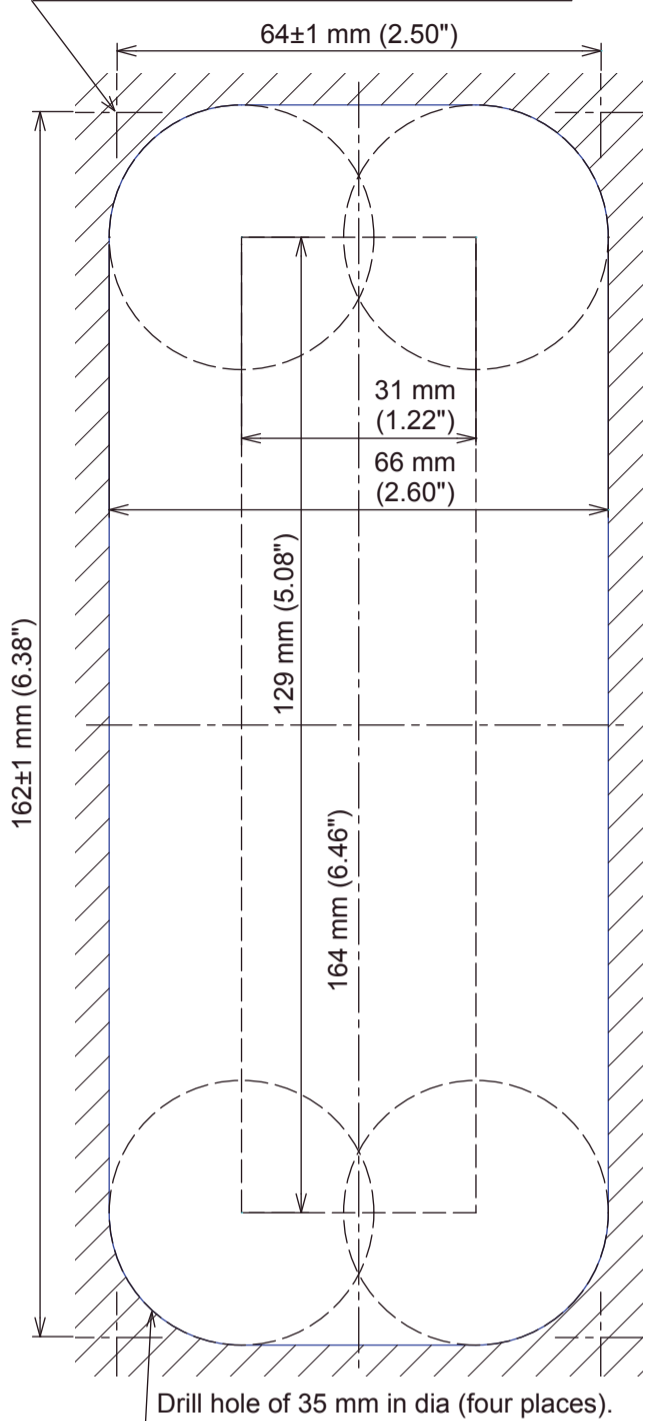

Drill hole of 35 mm in dia (four places).

Note: This template may have expanded or shrunk slightly. Please confirm dimensions before use.

How to install the Remote Control Unit

Included items

Name	Type	Code No.	Qty
Remote Control Unit	MCU-004	-	1
Self-tapping Screw	4×16 SUS 304	000-162-605-10	4
Screw Cap	19-032-3508-3	100-404-903-10	4
Hard Cover	19-032-3509-3	100-404-913-10	1

Procedure

- Using the mounting template on the left, cut a mounting hole in the installation site.
- Set the unit to the hole and secure the unit with four self-tapping screws ($\varnothing 4 \times 16$, supplied).
- Attach four screw caps (supplied).
- Connect the USB connector of the unit to the USB port of either the NavNet TZtouch or TZtouch2.

Note 1: When using a USB hub to connect this device, keep in mind that the maximum power consumption for this device is 270 mA.

Note 2: When you extend the USB cable by 5 m or more, a USB hub or USB repeater cable is required.

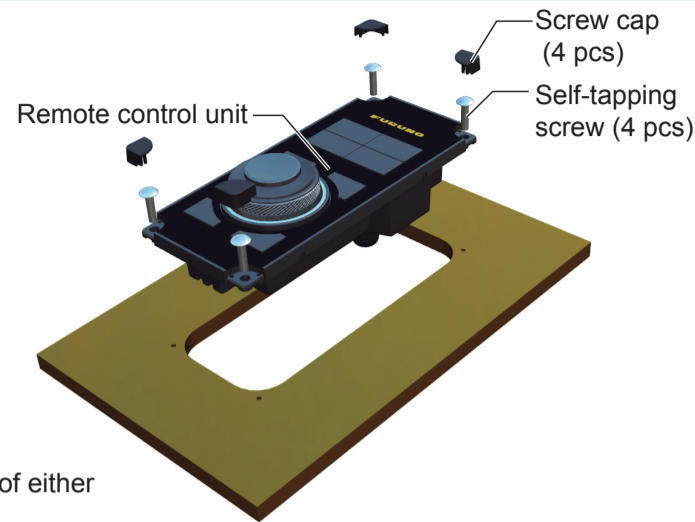

Outline and dimensions

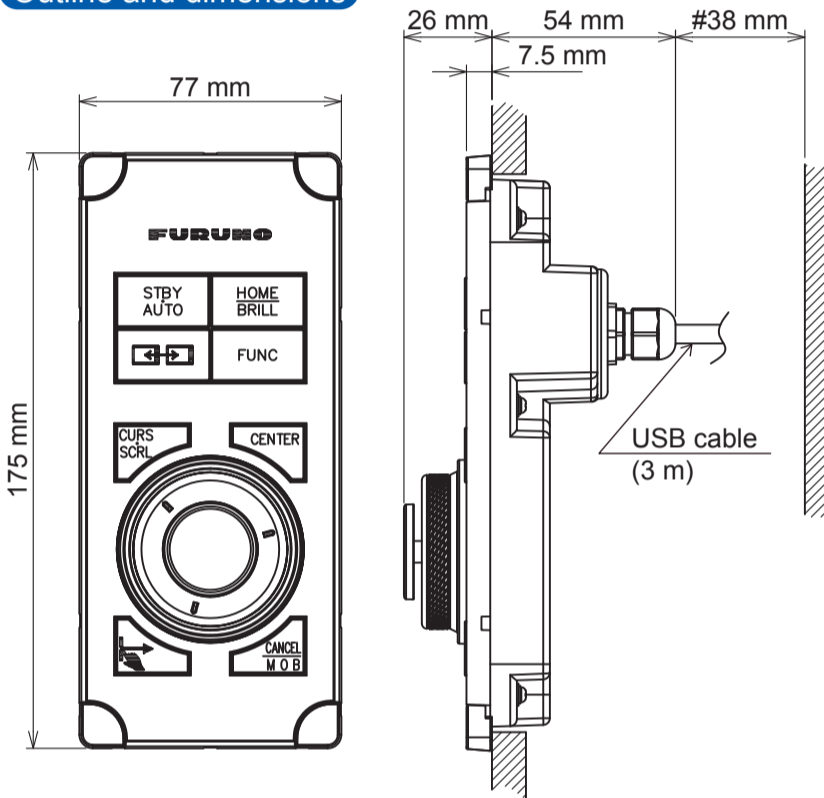

Specifications

Remote Control Unit MCU-004	
Ambient temperature	-15 °C to +55 °C
Relative humidity	93 % or less at 40 °C
Degree of protection	IP56 (front), IP22 (back)
Mass*	0.4 kg \pm 10 %
Power supply	USB bus power (Consumption current: Max. 270 mA)

*: Mass includes the hard cover and USB cable.

Notes

- Table shown below indicates tolerance of dimensions which are not specified.
- "#" indicates minimum service clearance.
- Use self-tapping screws ($\varnothing 4 \times 16$, included) to secure the unit.

DIMENSIONS (mm)	TOLERANCE (mm)
0 < L \leq 50	± 1.5
50 < L \leq 100	± 2.5
100 < L \leq 500	± 3

Control description



1 STBY·AUTO key

Switches the steering mode of the FURUNO NAVpilot-700 series Autopilot between the STBY and AUTO modes.

2 HOME/BRILL key

Short press: · Opens the home screen.
Long press: · Opens the Brilliance/Power window.

3 CONTROL key

Switches between displays that can be controlled with the MCU-004 when multiple displays are installed in the same network.

4 FUNC key

Activates the function set at [Function Gesture] in the [General] menu.

5 CURS·SCRL key

Switches the function of the joystick between the Cursor and Scroll modes.

6 CENTER key

· Returns your ship to the center of the screen (Plotter/Weather/Radar display).
· Cancels the echo history (Fish finder display).

7 Rotary knob

· Selects an item from the menu and dialog box.
· Zooms in (+) and out (-).

8 Joystick

Push: Works same as the tap gesture.

- Opens the pop-up menu.
- Activates the selected item.

Operate the joystick:

- in Cursor mode
 - Moves the cursor.
- in Scroll mode
 - Pans the display (Plotter/Weather/Radar display).
 - Shifts the range and scrolls back the picture (Fish finder display).

9 EDGE key

- TZT9/TZT14/TZTBB operation
Opens the RotoKey™ menu.
- TZTL12F/TZTL15F operation

Press the **EDGE** key and operate the joystick to activate the Edge Swipe function: Quick page, Slide-out menu, [Layers] menu, and Data area.

- Opens the [Layers] menu.
- Opens the Quick page.

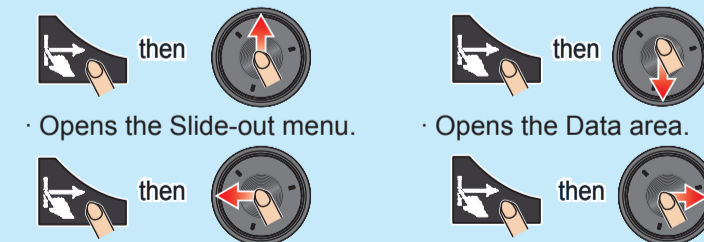

10 CANCEL/MOB key

Short press:

- Moves to the previous page or layer in a menu.
- Closes the menu or dialog box.
- Ends the tool mode (End Route, End Move, etc.).

Long press:

- Enters the MOB mark at the own ship's position.

Tips and Notice

- For TZT9/TZT14/TZTBB, the cross cursor is easier to use than the arrow cursor. To use the cross cursor, set [Cross Cursor] to [ON] in the [General] menu.
- The MCU-004 is compatible with the FURUNO Multi Function Displays and software version combinations shown below.
TZT9, TZT14, and TZTBB: Version 5.01 or later (Planned release: Beginning of 2017)
TZTL12F and TZTL15F: Version 3.01 or later (Planned release: Middle of 2016)



Note: The instructions and screenshots below are based the TZTL12F/TZTL15F.

Home screen operation

Press the **HOME/BRILL** key to open the home screen. The home screen is where you access functions and menus, select displays and check sensor status.



Display selection

Rotate the rotary knob to put the orange frame on the applicable display icon.

Push the joystick to open the selected display.

Menu operation

Rotate the rotary knob to put the orange frame on the applicable menu item.

Push the joystick to activate the selected item.

Zoom in and out

Rotate the rotary knob to zoom in or out the chart scale (Plotter/Weather display) and select the range (Radar/Fish finder display).

Zoom in

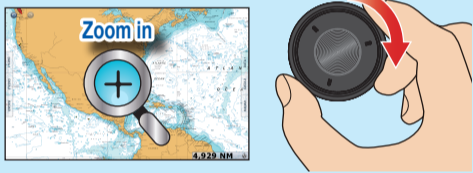

Zoom out



Edge Swipe function (TZTL12F/TZTL15F only)

Press the **EDGE** key and operate the joystick to activate the Edge Swipe function: Quick page, Slide-out menu, [Layers] menu, and Data area.

[Layers] menu



Data area

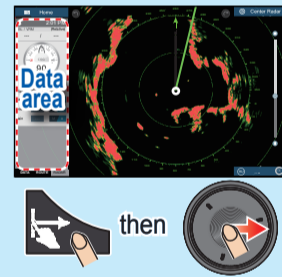

Quick page



Slide-out menu

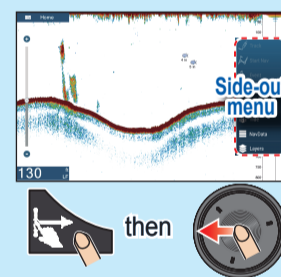

Cursor and Scroll modes

Press the **CURS-SCRL** key to switch the function of the joystick between the Cursor and Scroll modes.

Cursor mode operation

In the cursor mode, the cursor appears on the display other than the home screen and menu. Operate the joystick to move the cursor.



Scroll mode operation

In the scroll mode, you can pan the display (Plotter/Weather/Radar display), shift the range and scroll back the picture (Fish finder display) with the joystick.

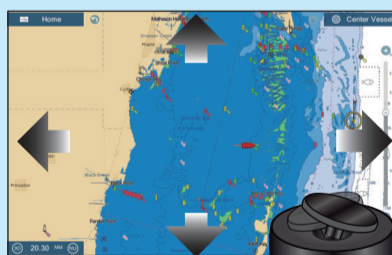

Tips

- In the cursor mode, you can pan the display by moving the cursor to the edge of the screen. This function is available in the full screen Plotter/Weather/Radar display.
- You can adjust the cursor speed on the [General] menu.

Switching displays and selecting an active window

Switching displays

When multiple displays are installed in the same network, press the **CONTROL** key to switch between displays that can be controlled with the MCU-004.

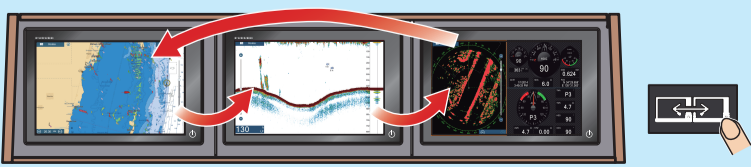

Selecting an active window

To select an active window in a split display, move the cursor on the applicable window. An orange frame appears around the current active window.

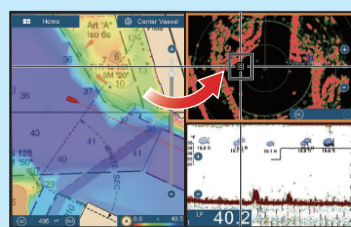

(Back of the mounting template)

How to inscribe/go to a point

How to inscribe a point

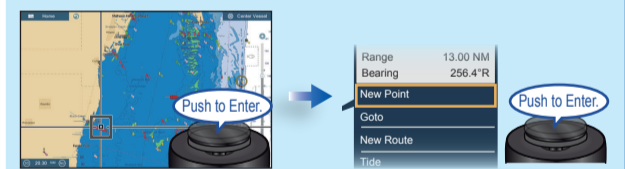

Move the cursor on the position to inscribe a point, then push the joystick.

Select [New Point].

How to go to a point

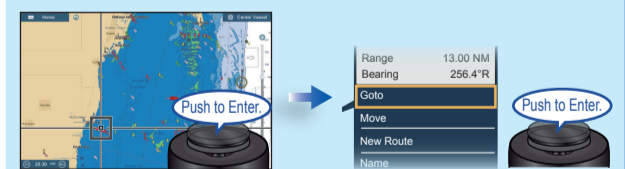

Move the cursor on the point or position to set as a temporary destination, then push the joystick.

Select [Goto].

How to inscribe an event mark



Open the Slide-out menu.

Select [Event].

Select a mark.

Push the joystick to inscribe the selected mark at the own ship position.